

# SIRUBA®

銀爺牌工業用縫紉機

INDUSTRIAL SEWING MACHINE

# L818F

WITH TRIMMER

## 零件圖 PARTS LIST



CE











高林股份有限公司  
KAULIN MFG. CO., LTD.

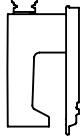

MODEL	SUB-CLASS	OPERATING PANEL	NEEDLE PLATE	FEED DOG	PRESSER FOOT	HOOK ASM	BOBBIN CASE ASM	BOBBIN	NEEDLE	HAND WHEEL
機 型	規 格	操作盒	針 板	送 具	押 具	梭 頭	梭 殼	梭 子	針 號	皮 帶 輪
L818F-L1-00 ~ L818F-L1-03	薄布料	LA55F-A	E701	D701	P721	G121	G202	G303	DA*1#9	GLH01-A1
L818F-L1-00A ~ L818F-L1-03A			E701	D701	P721	G121	G202	G303	DA*1#9	GLH01Q-E
L818F-L1-10 ~ L818F-L1-13			E701	D701	P721	G121	G202	G303	DA*1#9	GLH01-A1
L818F-M1-00 L818F-M1-03	薄中布 至 厚布料	LA55F-A	E704	D701	P701	G121	G202	G303	DB*1#14	GLH01-A1
L818F-M1-00A L818F-M1-03A			E704	D701	P701	G121	G202	G303	DB*1#14	GLH01Q-E
L818F-M1A-00 (L818F-M1C-00) L818F-M1A-03 (L818F-M1C-03)			E704D	D702	P701	G121	G202	G303	DB*1#14	GLH01-A1
L818F-M1A-00A (L818F-M1C-00A) L818F-M1A-03A (L818F-M1C-03A)	厚布料	L600	E704	D701	P701	G121	G202	G303	DB*1#14	GLH01-A1
L818F-M1-10 L818F-M1-13			E704D	D702	P701	G121	G202	G303	DB*1#14	GLH01Q-E
L818F-M1A-10 ( L818F-M1C-10 ) L818F-M1A-13 ( L818F-M1C-13 )			E704D	D702	P701	G121	G202	G303	DB*1#14	GLH01-A1

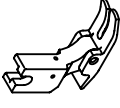
# 規格件表 CONVERSION CHART

MODEL	SUB-CLASS	OPERATING PANEL	NEEDLE PLATE	FEED DOG	PRESSER FOOT	HOOK ASM	BOBBIN CASE ASM	BOBBIN	NEEDLE	HAND WHEEL	
機型	規格	操作盒	針板	送具	押具	梭頭	梭殼	梭子	針號	皮帶輪	
L818F-HM1-00 L818F-HM1-03	薄中布 至 厚布料	LA55F-A	E704	D701	P701	G121	G202	G303	DB*1#14	GLH01-A1	
L818F-HM1A-00 L818F-HM1A-03			E704D	D702	P701	G121	G202	G303	DB*1#14	GLH01-A1	
L818F-HM1-10 L818F-HM1-13			HL600	E704	D701	P701	G121	G202	G303	DB*1#14	GLH01-A1
L818F-HM1A-10 L818F-HM1A-13			HL600	E704D	D702	P701	G121	G202	G303	DB*1#14	GLH01-A1

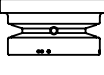
										
MODEL	SUB-CLASS	OPERATING PANEL	NEEDLE PLATE	FEED DOG	PRESSER FOOT	HOOK ASM	BOBBIN CASE ASM	BOBBIN	NEEDLE	HAND WHEEL
機 型	規 格	操作盒	針 板	送 具	押 具	梭 頭	梭 殼	梭 子	針 號	皮 帶 輪
L818F-H1-00 L818F-H1-03	中厚布 至 厚布料	LA55F-A	E711	D711	P711	G125	G202	G303	DB*1#21	GLH01-A1
L818F-H1-00A L818F-H1-03A			E711	D711	P711	G125	G202	G303	DB*1#21	GLH01Q-E
L818F-H1A-00 (L818F-H1C-00) L818F-H1A-03 (L818F-H1C-03)			E711D	D711D	P711D	G125	G202	G303	DB*1#21	GLH01-A1
L818F-H1A-00A (L818F-H1C-00A) L818F-H1A-03A (L818F-H1C-03A)			E711D	D711D	P711D	G125	G202	G303	DB*1#21	GLH01Q-E
L818F-H1-10 L818F-H1-13			H L600	D711	P711	G125	G202	G303	DB*1#21	GLH01-A1
L818F-H1A-10 (L818F-H1C-10) L818F-H1A-13 (L818F-H1C-13)			H L600	D711D	P711D	G125	G202	G303	DB*1#21	GLH01-A1

# 規格件表 CONVERSION CHART

MODEL 機 型	SUB-CLASS 規 格	OPERATING PANEL 操作盒	NEEDLE PLATE 針 板	FEED DOG 送 具	PRESSER FOOT 押 具	HOOK ASM 梭 頭	BOBBIN CASE ASM 梭 殼	BOBBIN 梭 子	NEEDLE 針 號	HAND WHEEL 皮 帶 輪
L818F-F1-00 ?	超 薄 布 料	L A55F-A	E721	D721	P721	G113	G202	G303	DB*1SF#9	GLH01-A1
L818F-F1-03										
L818F-F1-00A ?										
L818F-F1-03A										
L818F-F1-10 ?										
L818F-F1-13										
L818F-F1-20 ?										
L818F-F1-23										
L818F-F1-20A ?										
L818F-F1-23A										
L818F-F1-30 ?										
L818F-F1-33										
L818F-K1-00 ?										
L818F-K1-03										
L818F-K1-00A ?										
L818F-K1-03A										
L818F-K1-10 ?										
L818F-K1-13										

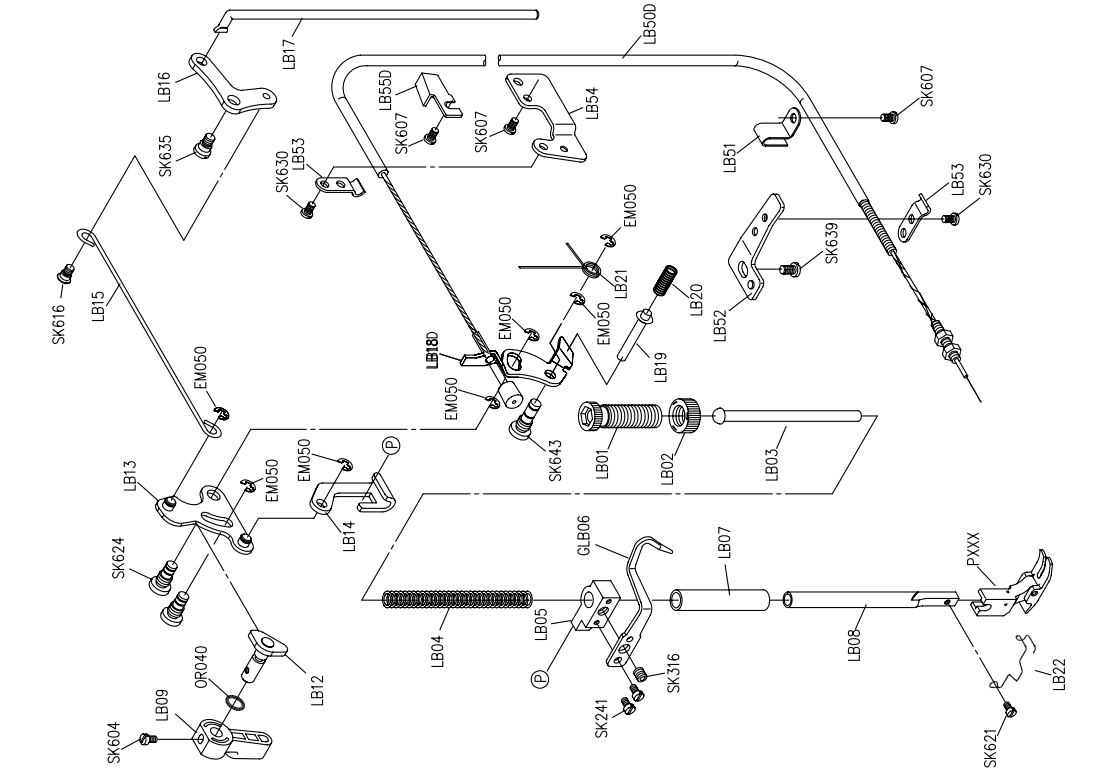

PARTS LIST FOR LB GROUP

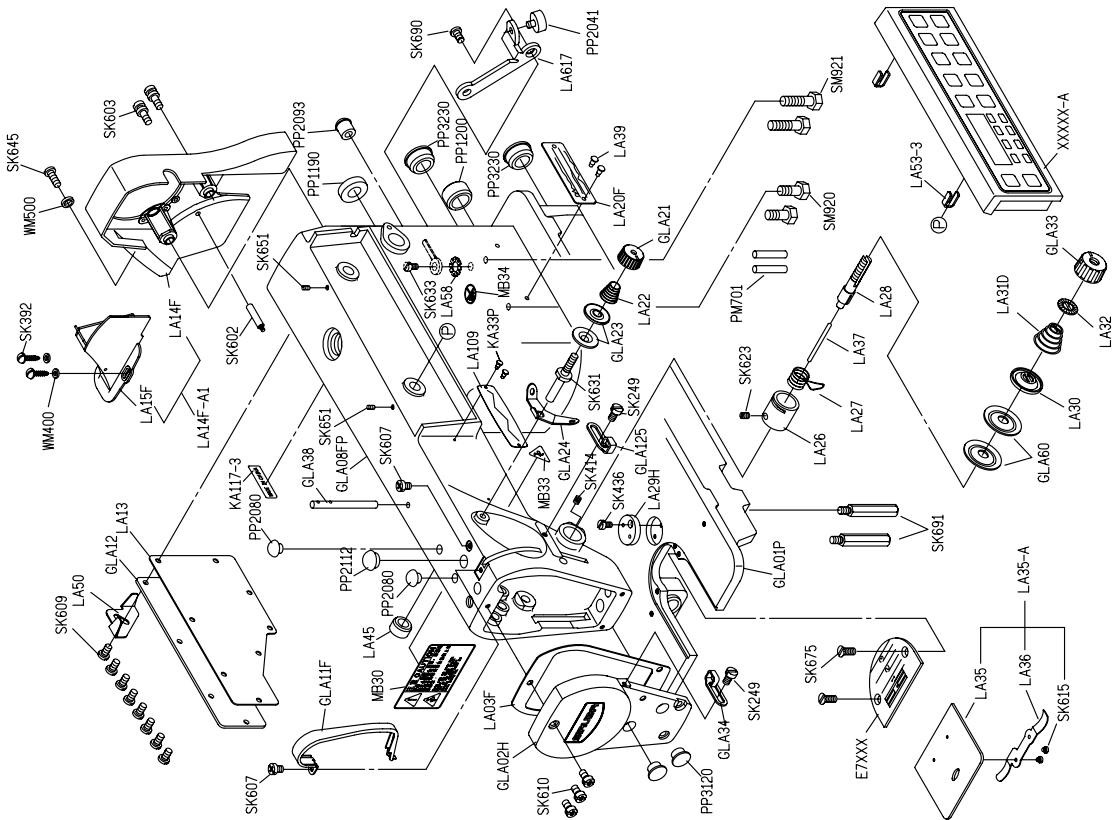

PARTS LIST FOR LA GROUP

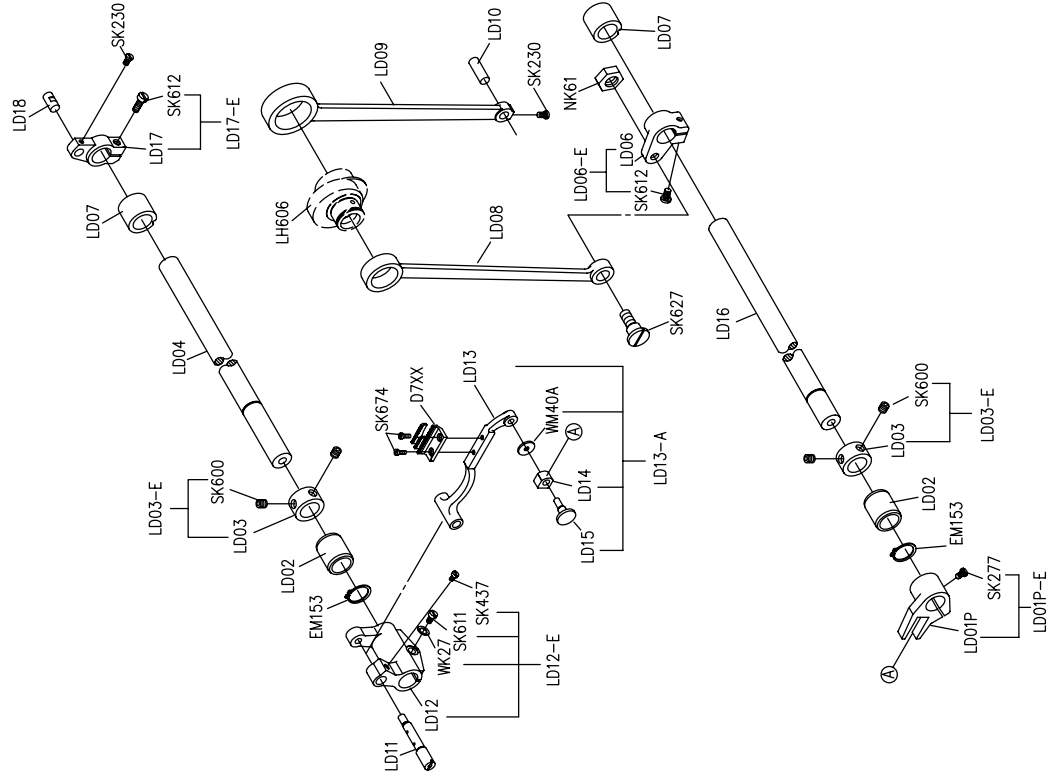
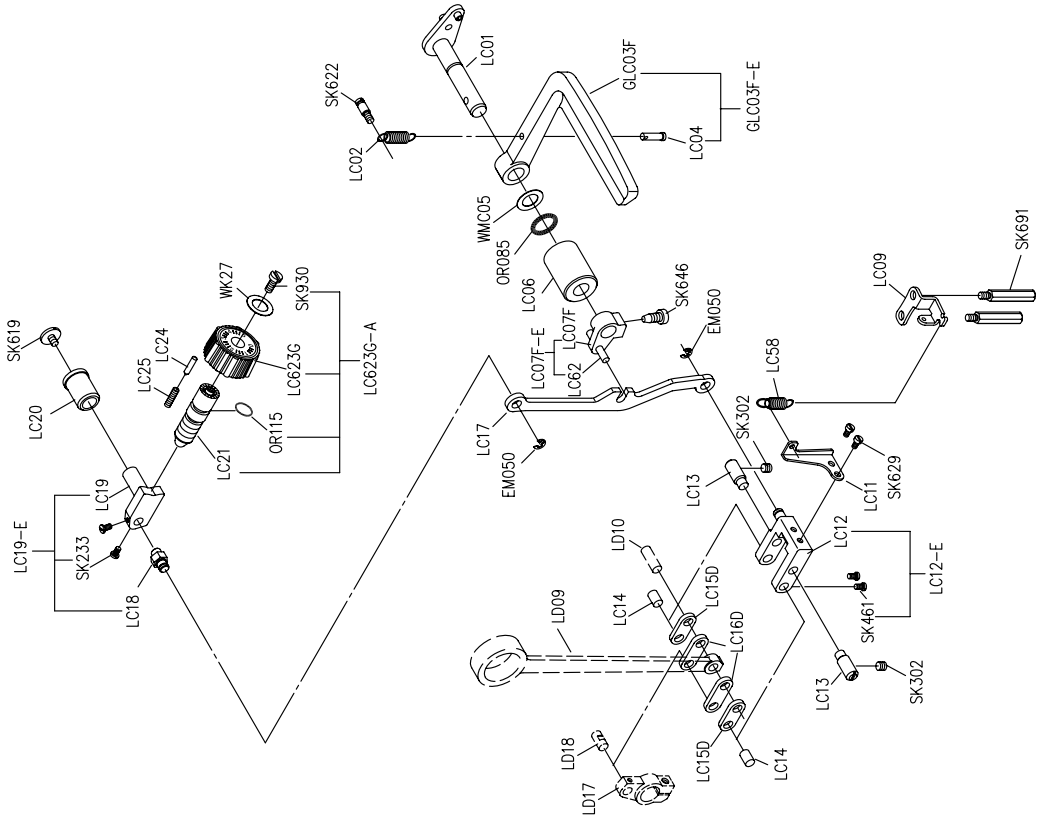



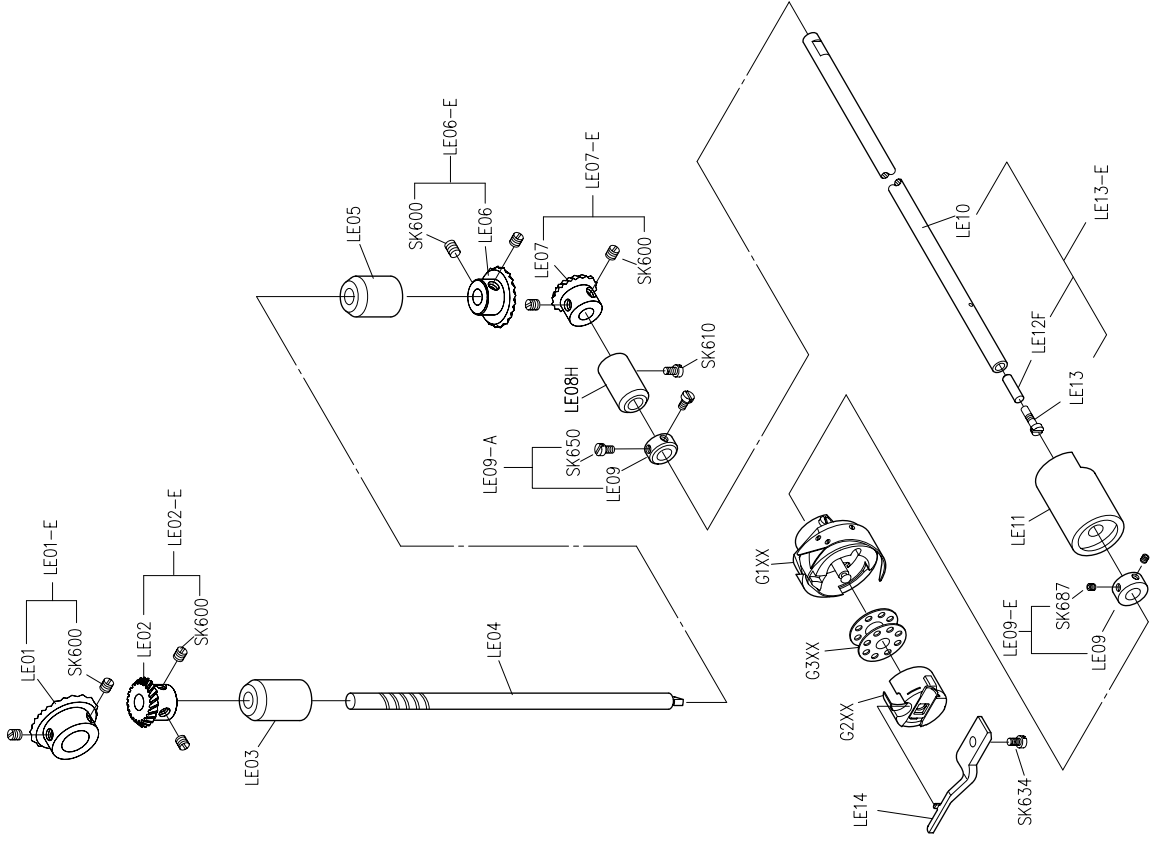

PARTS LIST FOR LE GROUP

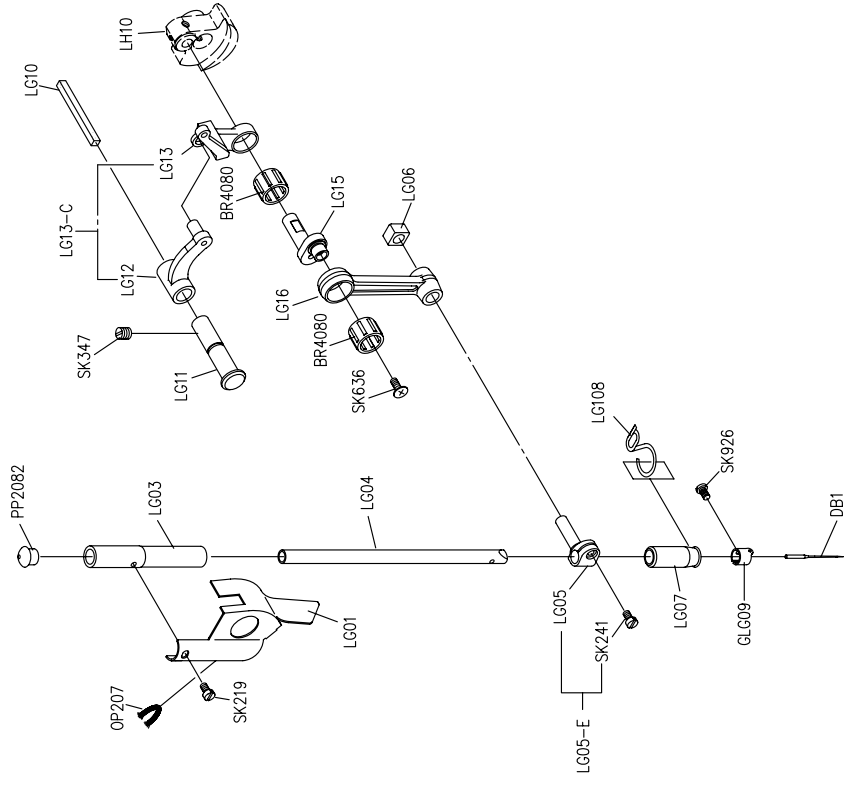

PARTS LIST FOR LG GROUP

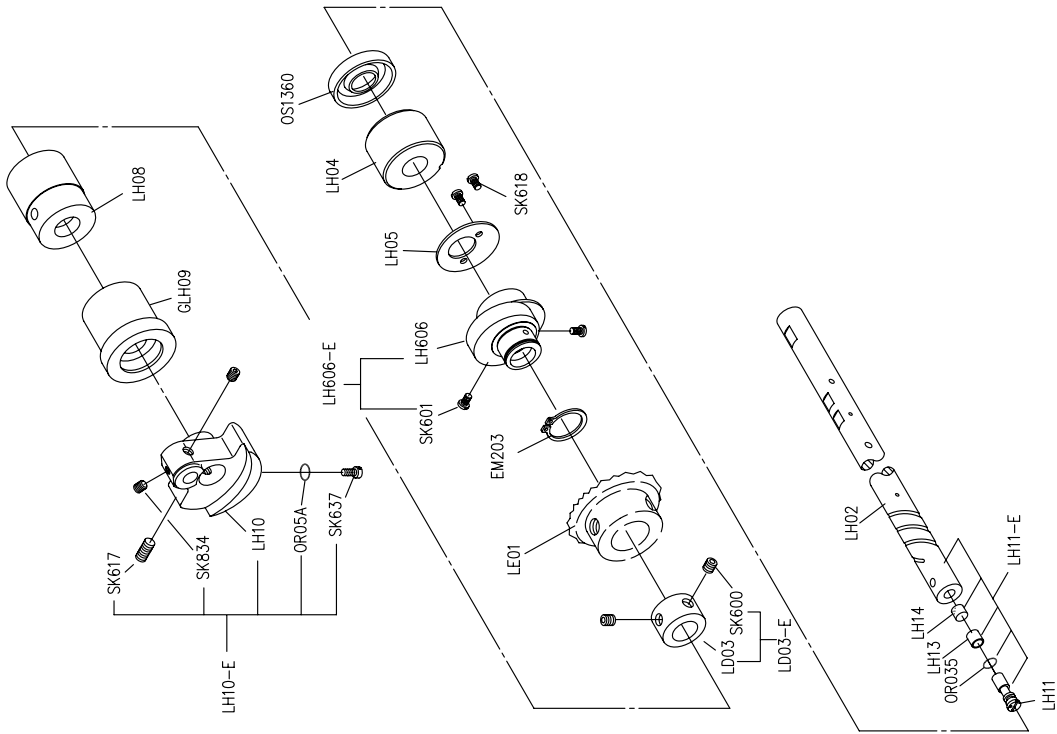

<p>H 廠牌馬達</p>	<p>擺動式切刀</p>	<p>旋轉式切刀</p>
<p>其他廠牌馬達(可加後拉輪)</p>		
<p>P 廠牌馬達</p>		
<p>P 廠牌馬達(可加後拉輪)</p>		

LM01H-A

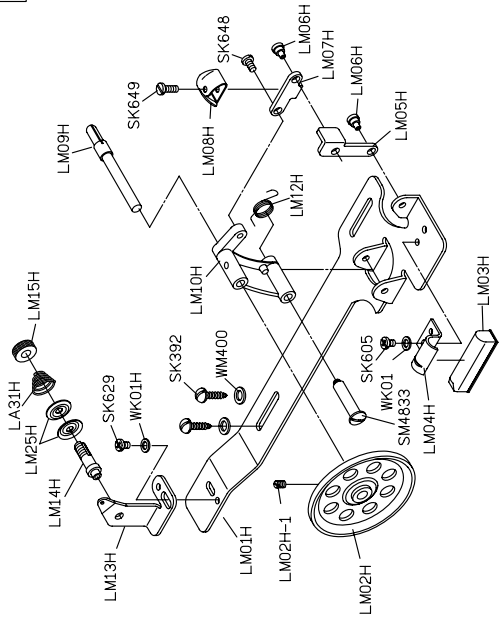

LM24-E

LM20-A

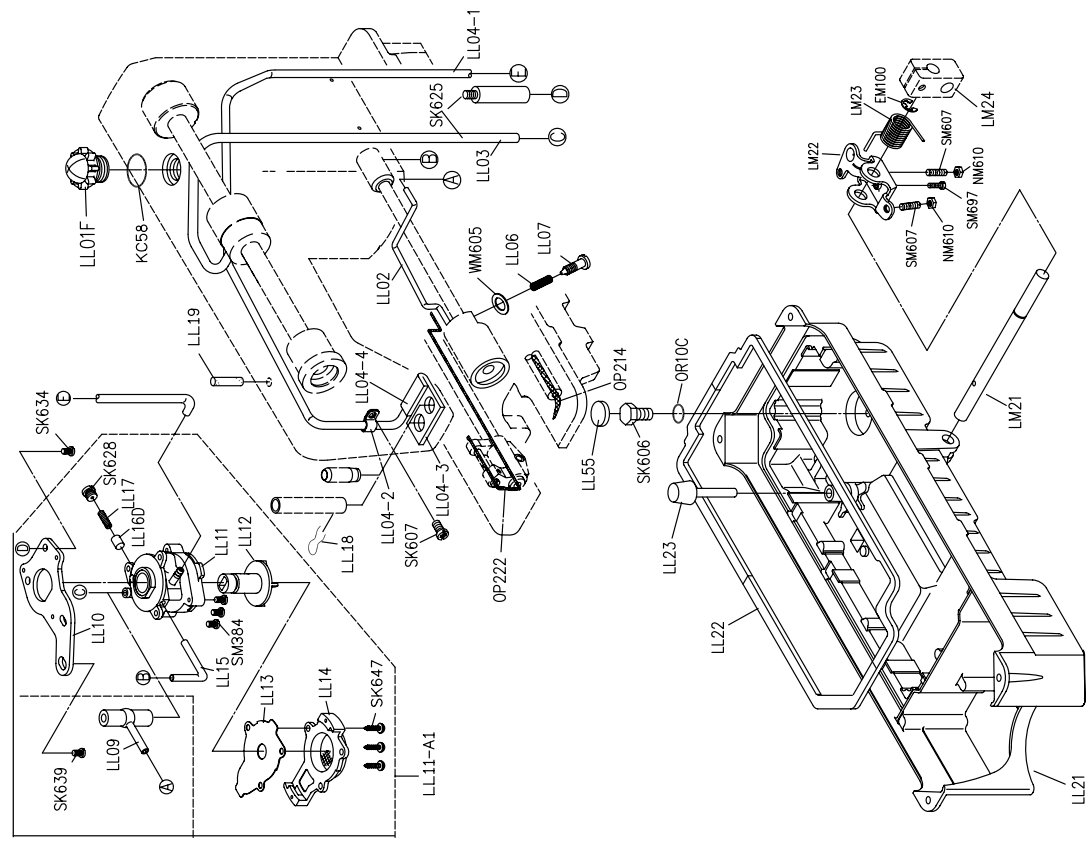
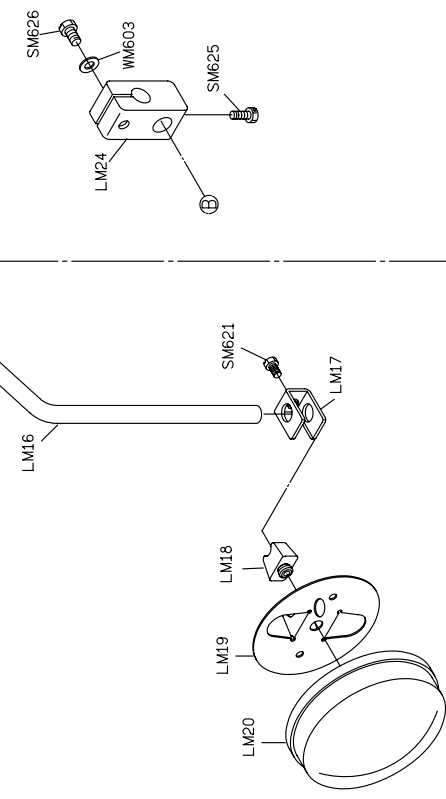

PARTS LIST FOR LL GROUP

PARTS LIST FOR LM GROUP

# PARTS LIST FOR LU GROUP

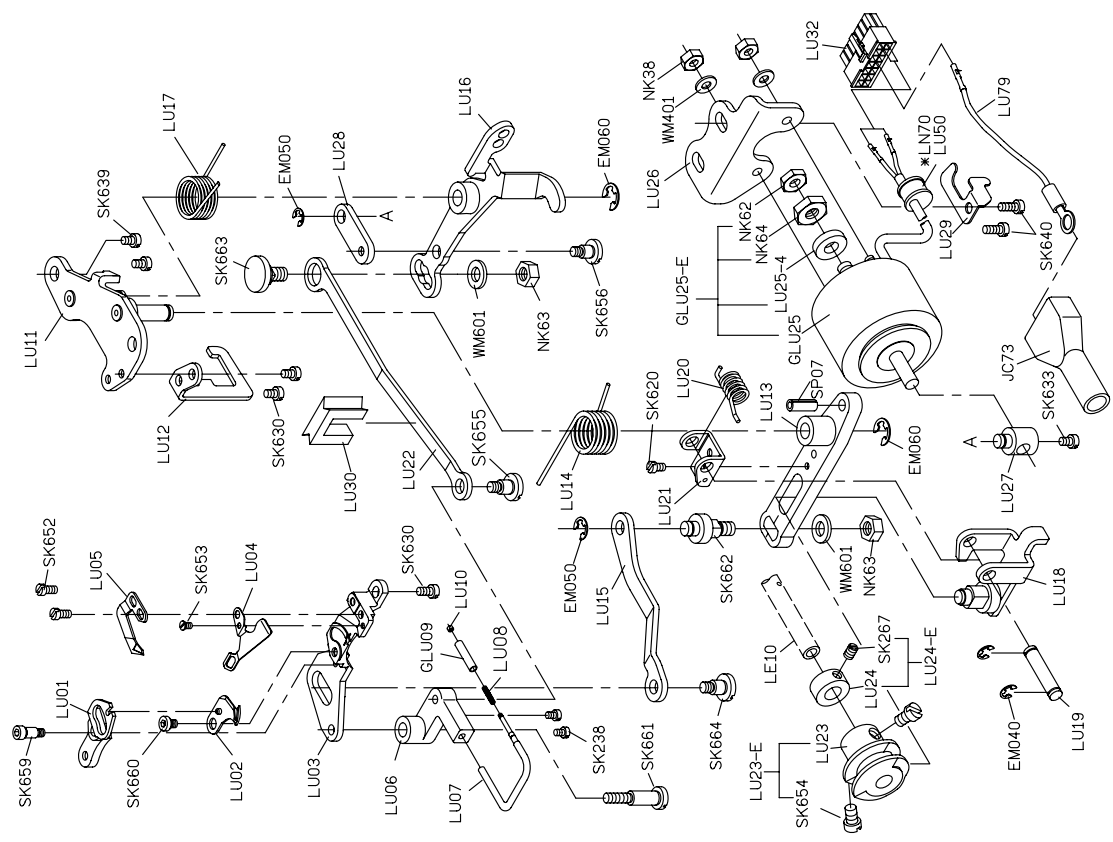

# PARTS LIST FOR LU GROUP

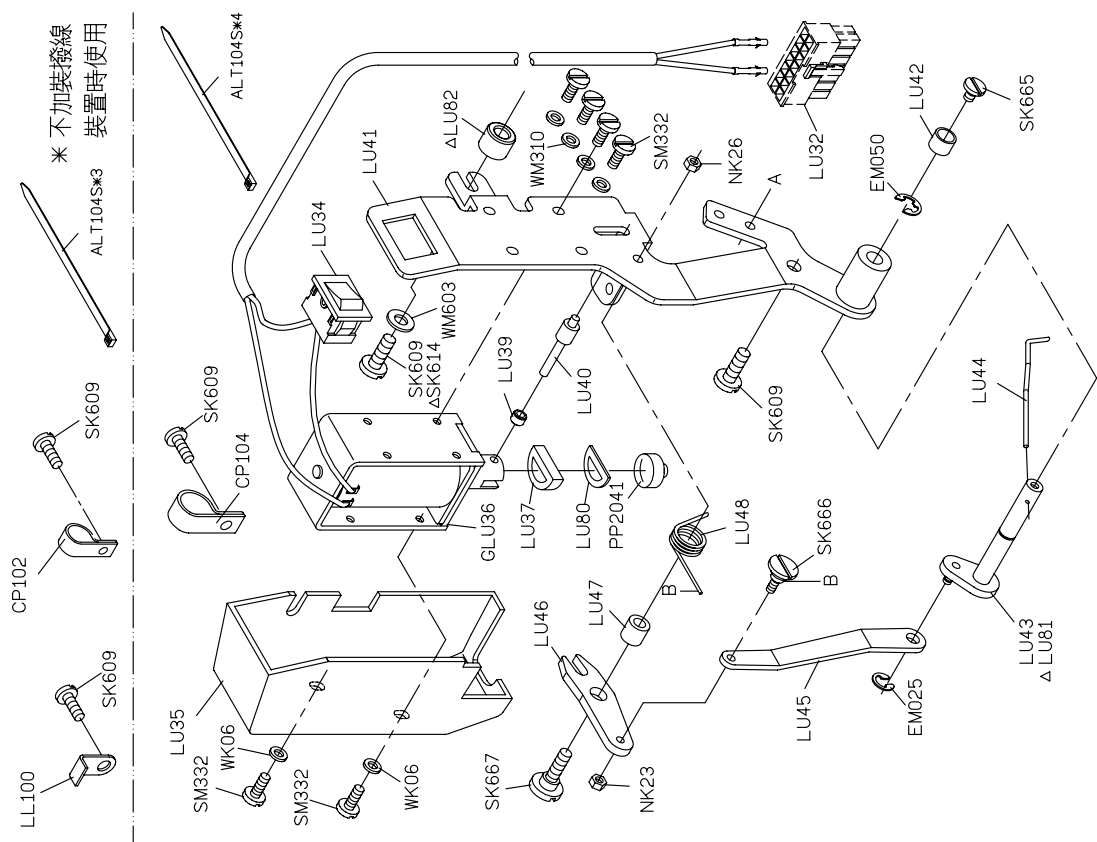

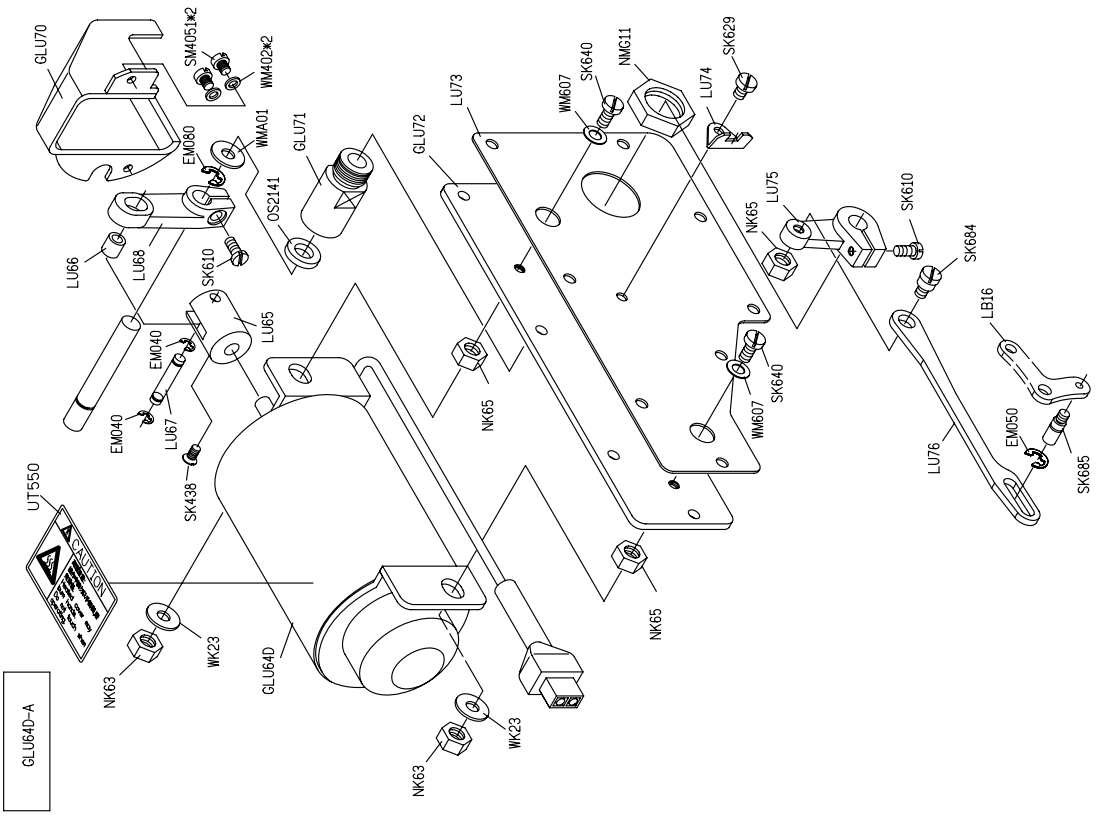

GLU640-A

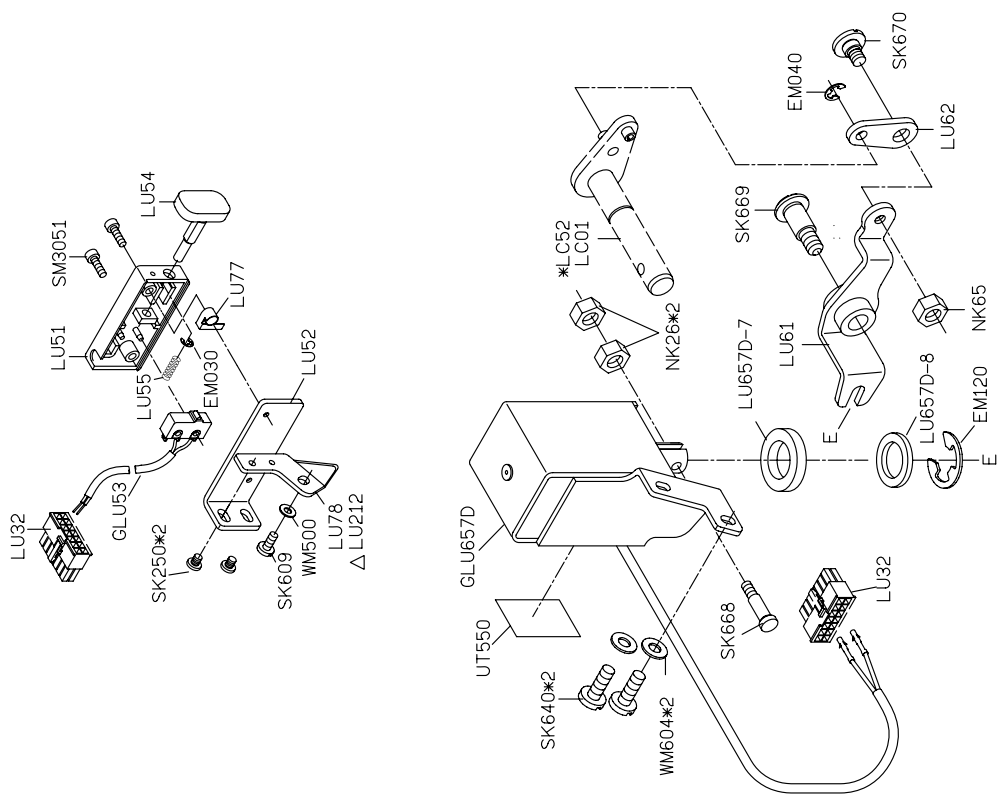

GLU657D

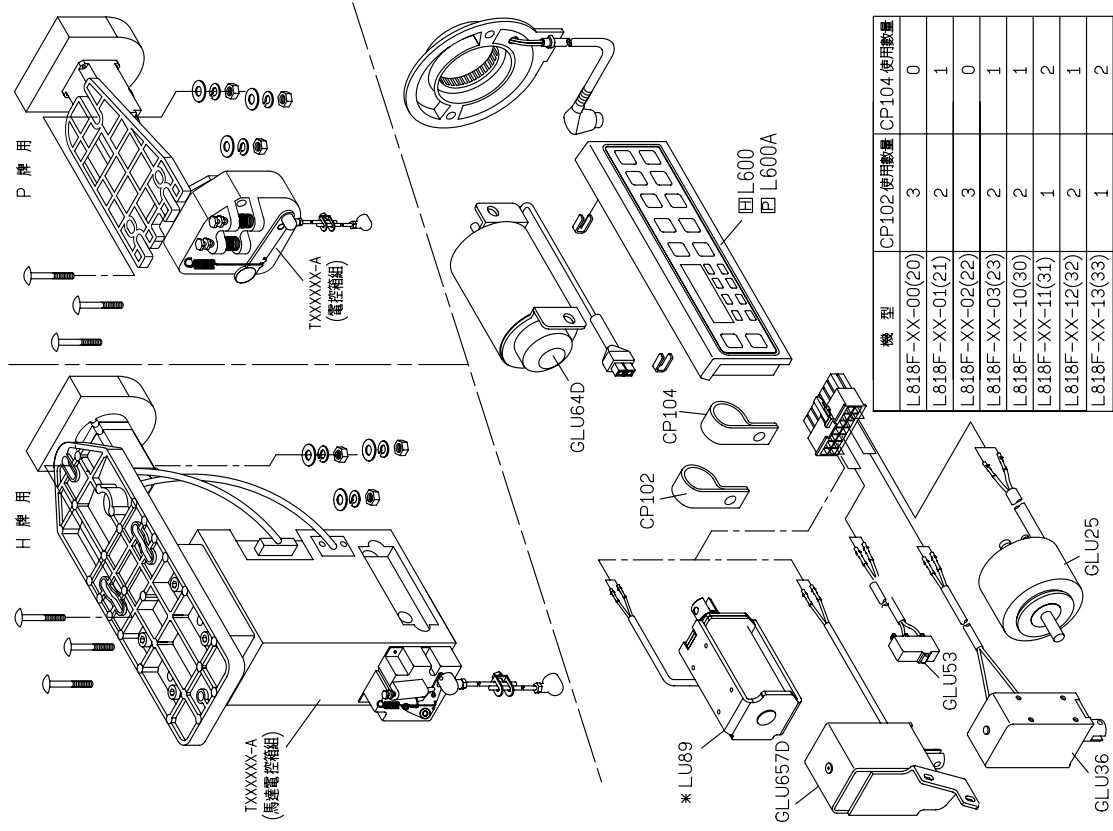

\* ONLY FOR L818F-NF TRIMMER

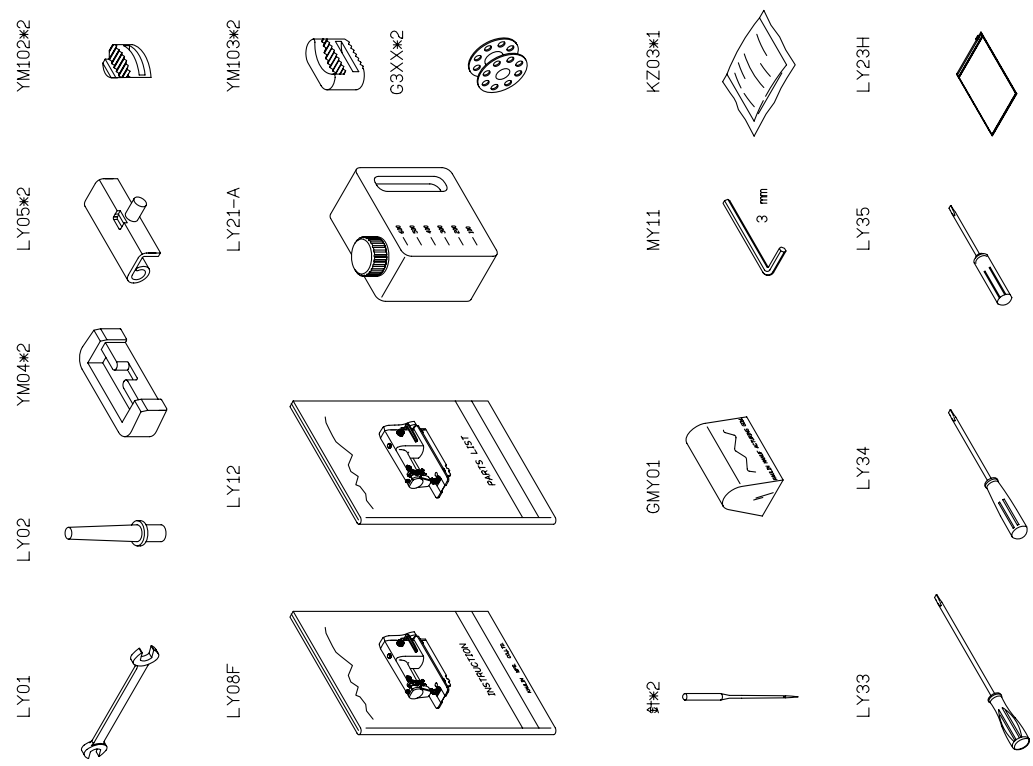

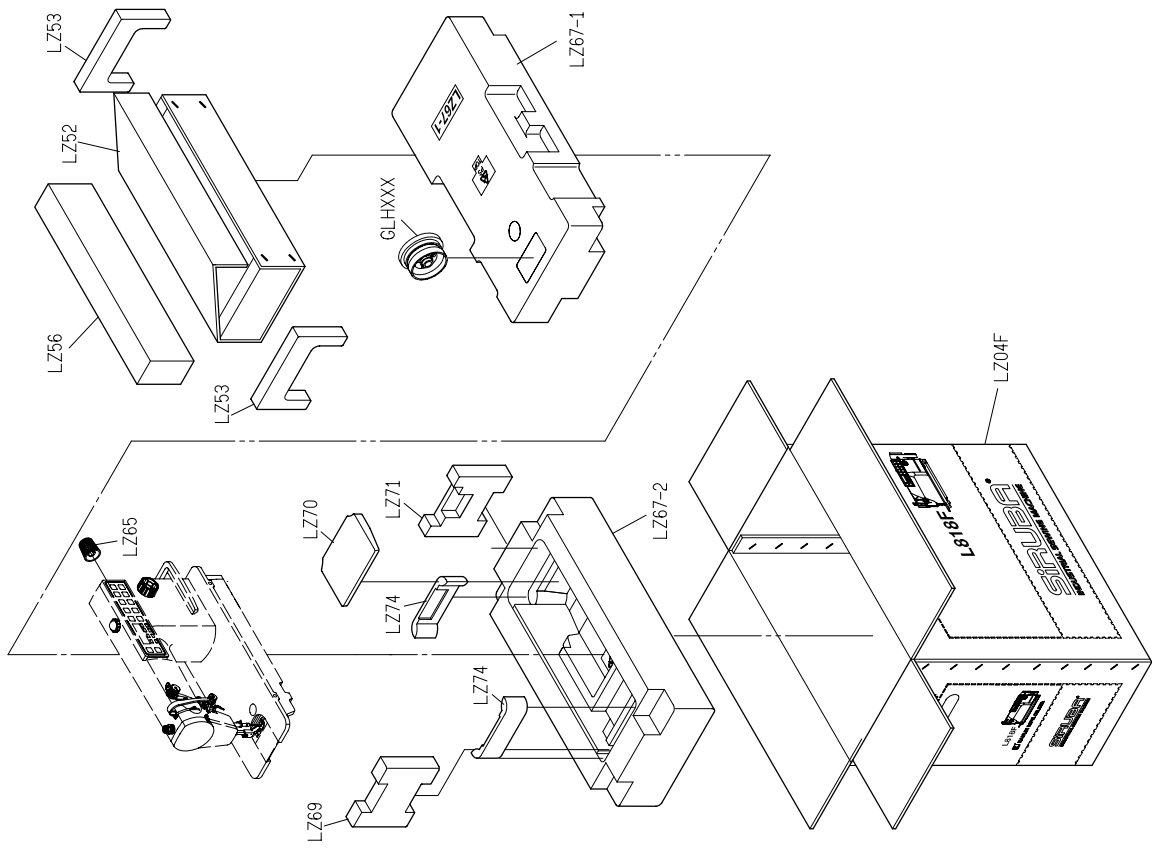
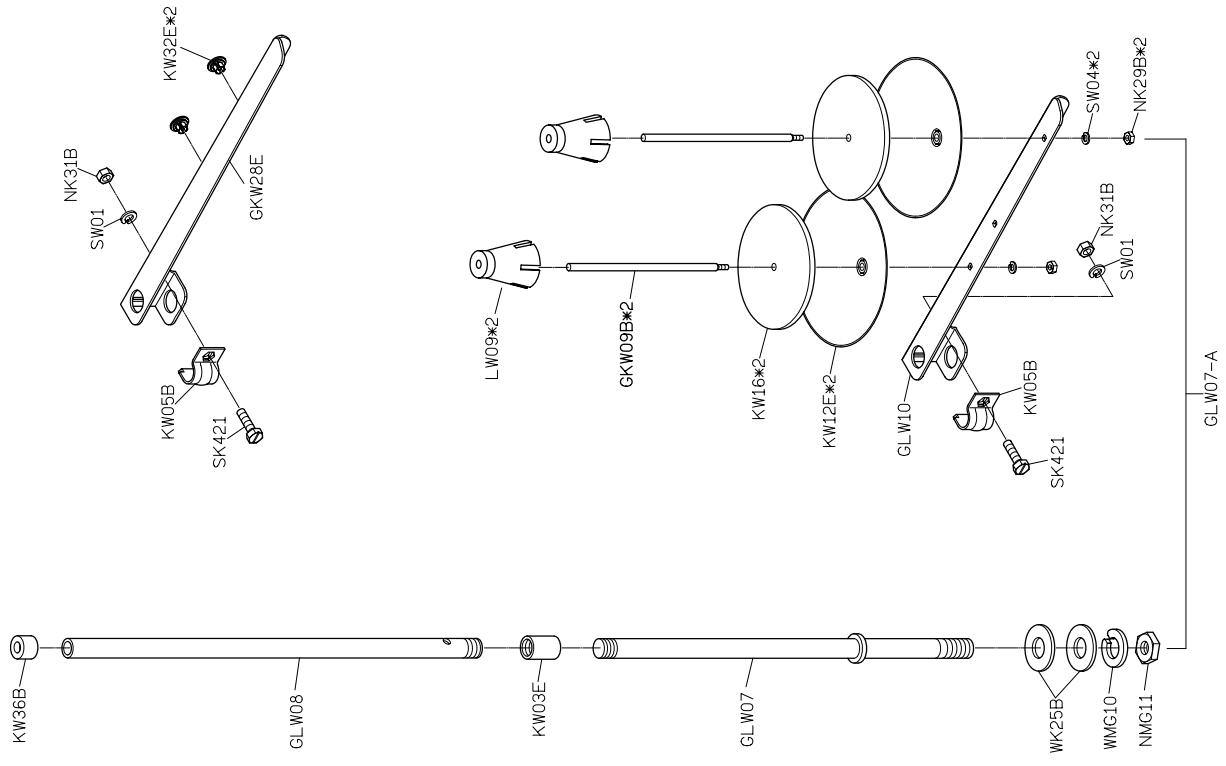

**PARTS LIST FOR THREAD STAND GROUP**

**PARTS LIST FOR LZ GROUP**



# L818F

WITH TRIMMER

高林股份有限公司 KAULIN MFG. CO., LTD.